

Catalog tehnic

Sistemul pluvial Scandic®

Produsele exemplificate sunt realizate din materie primă SSAB GreenCoat RWS, RAL 3009

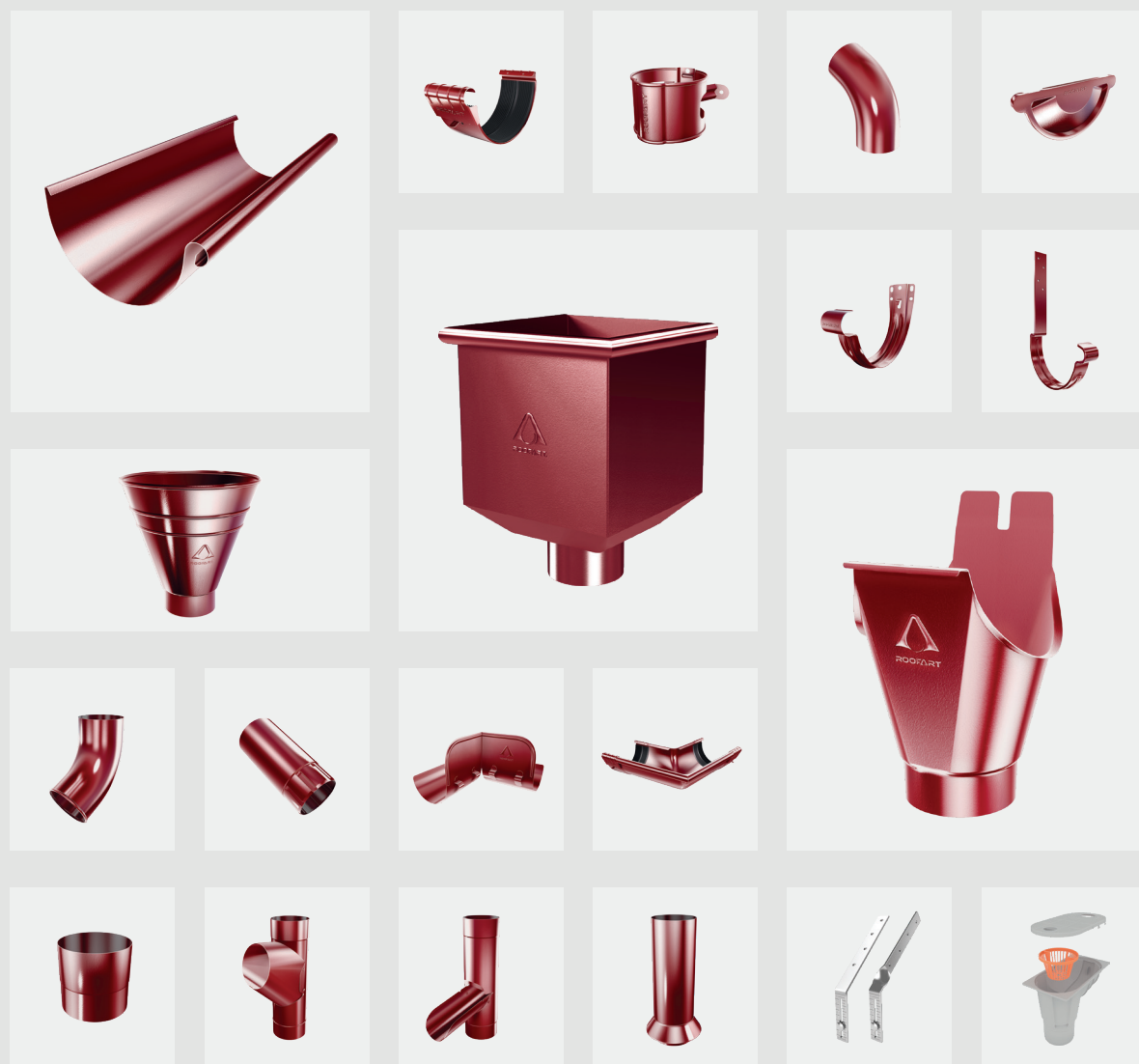

Detalii și caracteristici pentru ambalare și transport





Cuprins

- 3 JB - Jgheab L-3000
- 4 JB - Jgheab L-4000
- 5 BJ - Brățară jgheab
- 6 CU - Capac universal
- 7 CJ - Cârlig jgheab
- 8 CJL - Cârlig jgheab lung
- 9 CPU - Cârlig pazie universal
- 10 PPC/ PPCR - Piesă prindere cârlig / răsucită
- 11 PP - Piesă preaplin 90°
- 12 PP - Piesă preaplin 180°
- 13 KIB - Colțar interior 90° cu brățări incluse
- 14 KEB - Colțar exterior 90° cu brățări incluse
- 15 KI - Colțar interior 90°
- 16 KE - Colțar exterior 90°
- 17 RA - Racord jgheab
- 18 PC - Pâlnie colectoare
- 19 PCD - Pâlnie colectoare dreptunghiulară
- 20 CB - Cot burlan 60°
- 21 BU - Burlan
- 22 PB - Prelungitor burlan
- 23 MB - Mufă burlan
- 24 BB - Brățară burlan
- 25 RB - Ramificație burlan
- 26 EC - Element captare
- 27 RC - Racord canalizare
- 28 CE - Cot evacuare 60°
- 29 EJ - Element rigidizare jgheab
- 29 SJ - Stabilizator jgheab
- 30 DEP - Decantor pluvial
- 30 CEL - Cot elastic

Verificați instrucțiunile video de instalare pe canalul de YouTube RoofArt

Accesați linkul sau scanați QR Codul

<https://www.youtube.com/@RoofartEU/videos>

Denumire video: Cum se monteaza jgheburile si burlanele - Sistemul pluvial Scandic®

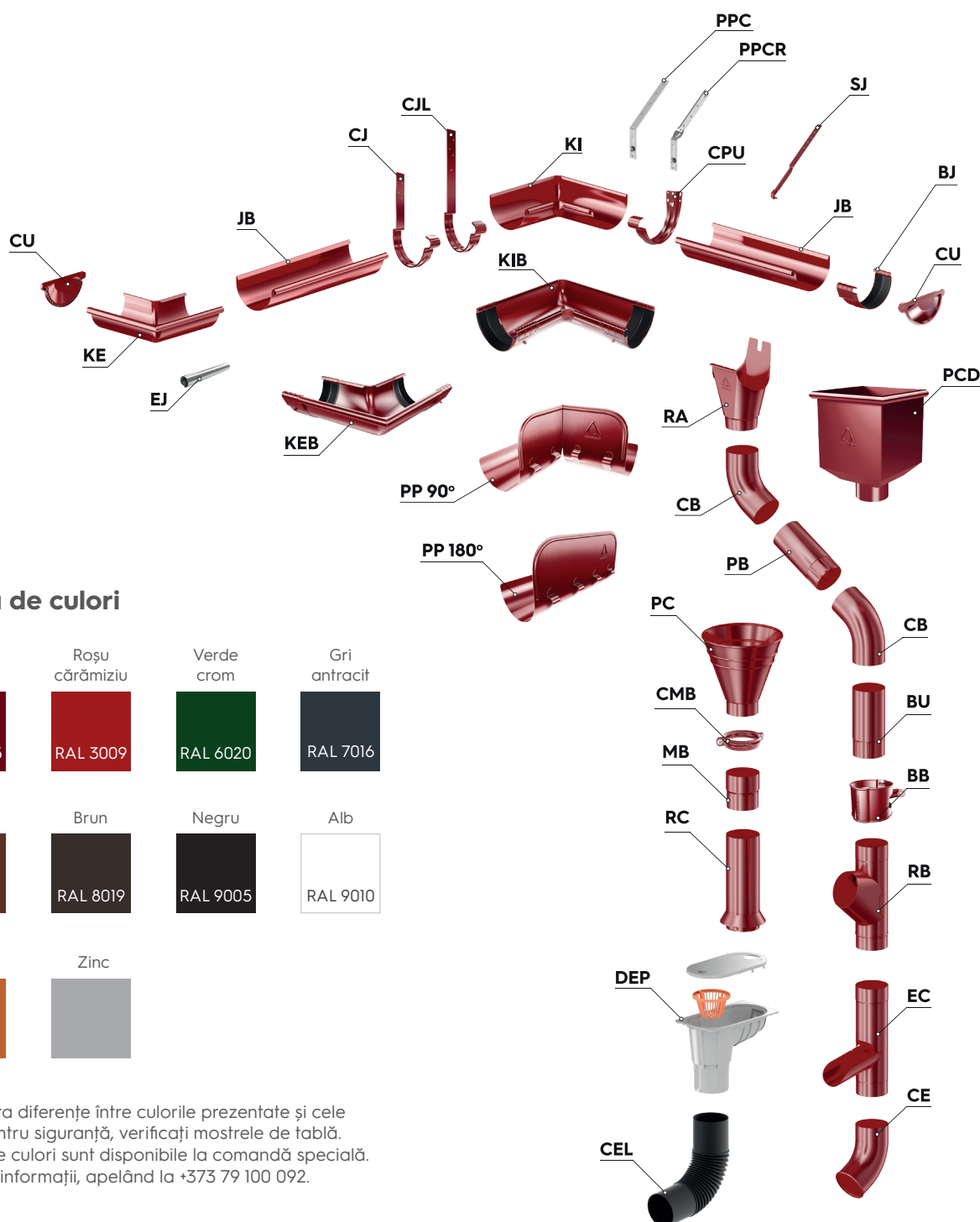

Gamă de culori

Vișiniu RAL 3005	Roșu cărămiziu RAL 3009	Verde crom RAL 6020	Gri antracit RAL 7016
Maro RAL 8017	Brun RAL 8019	Negru RAL 9005	Alb RAL 9010
Cupru	Zinc		

*Pot exista diferențe între culorile prezentate și cele reale. Pentru siguranță, verificați mostrele de tablă.
**Anumite culori sunt disponibile la comandă specială.
Solicitați informații, apelând la +373 79 100 092.

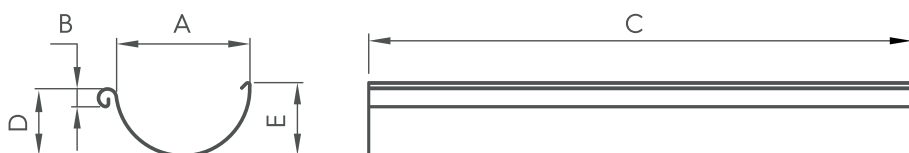
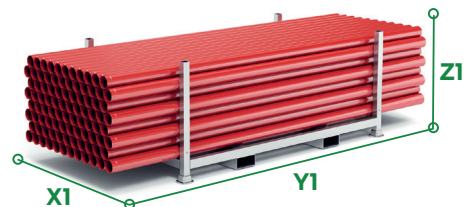
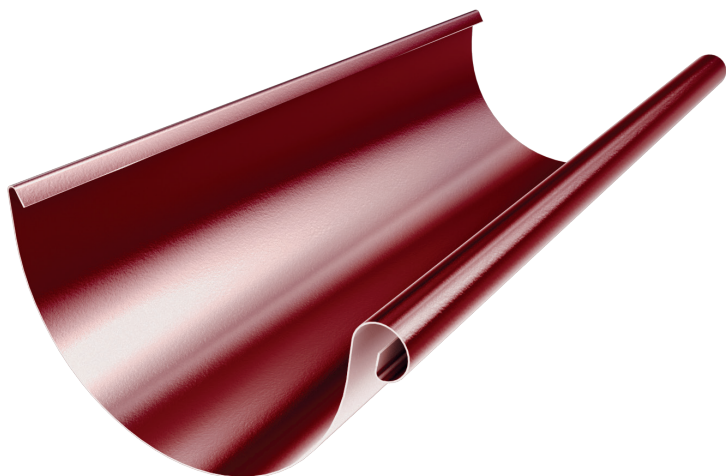

Dimensiuni element (mm)

	125/87	150/100
A	125	150
B	18	20
C	3000	3000
D	62	86
E	68	97

Dimensiuni palet (mm)

	125/87	150/100
X1	1200	1200
Y1	3000	3000
Z1	810	810

JB 125

Cod de bare EAN-13	Culori
4.841.159.000.635	Vișiniu
4.841.159.000.376	Roșu oxid
4.841.159.000.116	Roșu
4.841.159.010.450	Verde crom
4.841.159.007.191	Gri metalic
4.841.159.016.964	Gri antracit
4.841.159.007.771	Cărămiziu
4.841.159.000.895	Maro
4.841.159.005.821	Brun
4.841.159.006.408	Negru
4.841.159.001.151	Alb
4.841.159.005.265	Cupru
4.841.159.004.015	Zinc

JB 150

RAL	Cod de bare EAN-13
3005	4.841.159.001.939
3009	4.841.159.001.670
3011	4.841.159.001.410
6020	4.841.159.010.757
7011	4.841.159.007.481
7016	4.841.159.017.244
8004	4.841.159.008.068
8017	4.841.159.002.196
8019	4.841.159.006.118
9005	4.841.159.006.699
9010	4.841.159.002.455
	4.841.159.005.548
	4.841.159.004.275

JB 125

JB 150

Bucăți în cutie		
	5	5
Cuții pe palet		
	65	55
Cutie		
	16.5	22
Palet		
	1156	1294

EN 612:2006

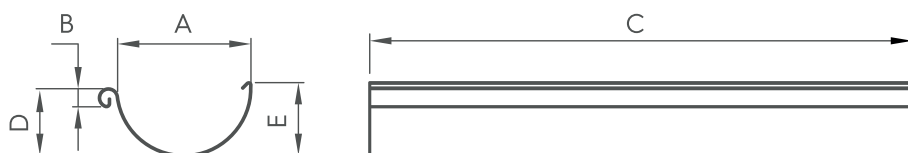
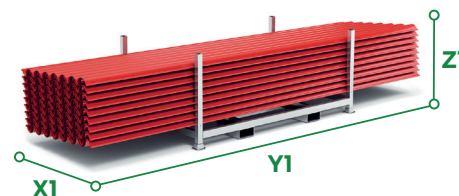
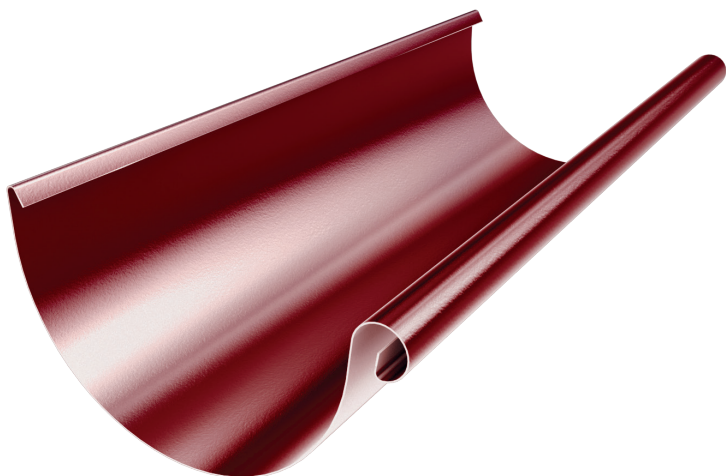
Dimensiuni element (mm)

	125/87	150/100
A	125	150
B	18	20
C	4000	4000
D	62	86
E	68	97

Dimensiuni palet (mm)

	125/87	150/100
X1	1200	1200
Y1	4000	4000
Z1	810	810

JB 125
JB 150

Cod de bare EAN-13	Culori	RAL	Cod de bare EAN-13
4.841.159.000.642	Vișiniu	3005	4.841.159.001.946
4.841.159.000.383	Roșu oxid	3009	4.841.159.001.687
4.841.159.000.123	Roșu	3011	4.841.159.001.427
4.841.159.010.467	Verde crom	6020	4.841.159.010.764
4.841.159.007.207	Gri metalic	7011	4.841.159.007.498
4.841.159.016.995	Gri antracit	7016	4.841.159.017.251
4.841.159.007.788	Cărămiziu	8004	4.841.159.008.075
4.841.159.000.901	Maro	8017	4.841.159.002.202
4.841.159.005.838	Brun	8019	4.841.159.006.125
4.841.159.006.415	Negru	9005	4.841.159.006.705
4.841.159.001.168	Alb	9010	4.841.159.002.462
4.841.159.005.272	Cupru		4.841.159.005.555
4.841.159.004.022	Zinc		4.841.159.004.282

JB 125
JB 150

	JB 125	JB 150
Bucăți în cutie		
	5	5
Cuții pe palet		
	52	44
Cutie		
	22.0	29.3
Palet		
	1228	1373

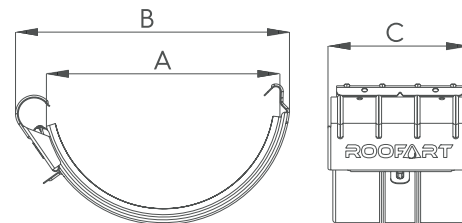
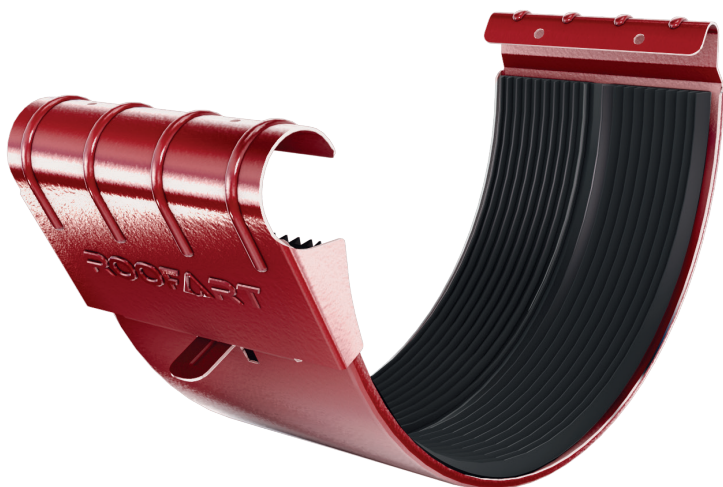

Dimensiuni element (mm)

	125/87	150/100
A	125	150
B	145	176
C	72	72

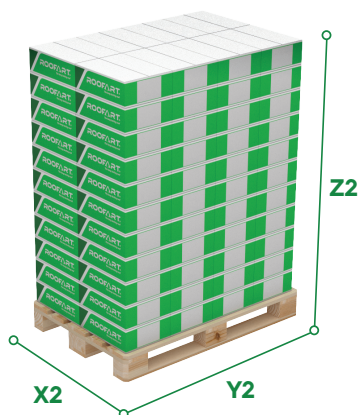

Dimensiuni palet (mm)

	125/87	150/100
X2	800	800
Y2	1200	1200
Z2	1680	1680

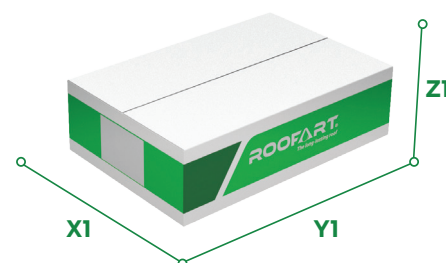

Dimensiuni cutie (mm)

	125/87	150/100
X1	290	290
Y1	390	390
Z1	170	170

BJ 125

Cod de bare EAN-13	Culori
4.841.159.000.659	Vişiniu
4.841.159.000.390	Roşu oxid
4.841.159.000.130	Roşu
4.841.159.010.474	Verde crom
4.841.159.007.214	Gri metalic
4.841.159.016.988	Gri antracit
4.841.159.007.795	Cărămiziu
4.841.159.000.918	Maro
4.841.159.005.845	Brun
4.841.159.006.422	Negru
4.841.159.001.175	Alb
4.841.159.005.289	Cupru
4.841.159.004.039	Zinc

BJ 150

RAL	Cod de bare EAN-13
3005	4.841.159.001.953
3009	4.841.159.001.694
3011	4.841.159.001.434
6020	4.841.159.010.771
7011	4.841.159.007.504
7016	4.841.159.017.268
8004	4.841.159.008.082
8017	4.841.159.002.219
8019	4.841.159.006.132
9005	4.841.159.006.712
9010	4.841.159.002.479
	4.841.159.005.562
	4.841.159.004.299

BJ 125 BJ 150

	BJ 125	BJ 150
Bucăţi în cutie		
	40	40
Cuţii pe palet		
	72	72
Cutie		
	5.8	7.3
Palet		
	438	546

Notă: Pot exista diferenţe între culorile prezentate şi cele reale. Pentru siguranţă, verificaţi mostrele de tablă.

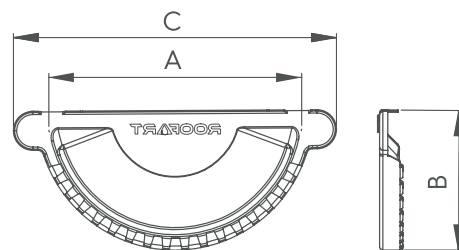

Dimensiuni element (mm)

	125/87	150/100
A	125	150
B	69	95
C	159	192



Dimensiuni cutie (mm)

	125/87	150/100
X1	200	200
Y1	300	300
Z1	110	110

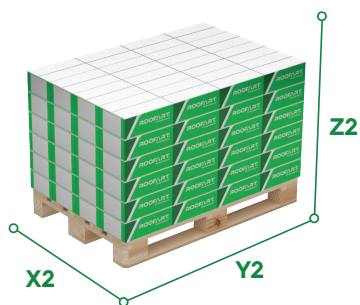

Dimensiuni palet (mm)

	125/87	150/100
X2	800	800
Y2	1200	1200
Z2	1030	1030

CU 125

Cod de bare EAN-13	Culori
4.841.159.000.666	Vișiniu
4.841.159.000.406	Roșu oxid
4.841.159.000.147	Roșu
4.841.159.010.481	Verde crom
4.841.159.007.221	Gri metalic
4.841.159.017.008	Gri antracit
4.841.159.007.801	Cărămiziu
4.841.159.000.925	Maro
4.841.159.005.852	Brun
4.841.159.006.439	Negru
4.841.159.001.182	Alb
4.841.159.005.296	Cupru
4.841.159.004.046	Zinc

CU 150

RAL	Cod de bare EAN-13
3005	4.841.159.001.960
3009	4.841.159.001.700
3011	4.841.159.001.441
6020	4.841.159.010.788
7011	4.841.159.007.511
7016	4.841.159.017.275
8004	4.841.159.008.099
8017	4.841.159.002.226
8019	4.841.159.006.149
9005	4.841.159.006.729
9010	4.841.159.002.486
	4.841.159.005.579
	4.841.159.004.305

CU 125 CU 150

	CU 125	CU 150
Bucăți în cutie		
	34	27
Cuții pe palet		
	128	128
Cutie		
	2.1	2.6
Palet		
	290	353

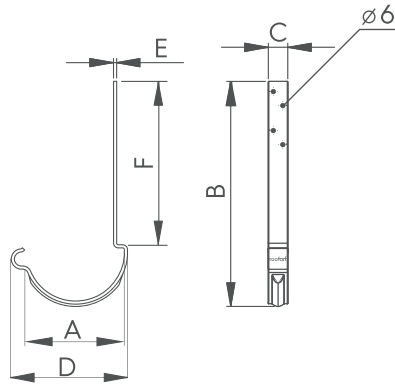

Dimensiuni element (mm)

	125/87	150/100
A	125	150
B	265	290
C	25	25
D	150	177
E	4	4
F	185	185

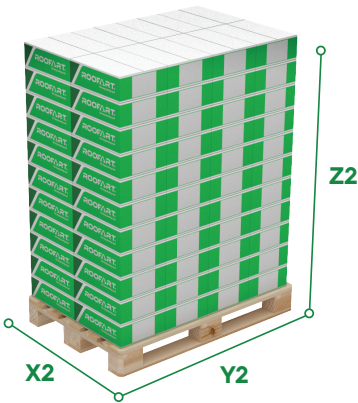

Dimensiuni palet (mm)

	125/87	150/100
X2	800	800
Y2	1200	1200
Z2	1580	1580

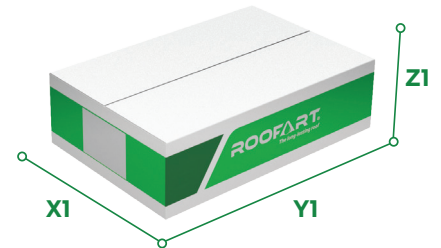

Dimensiuni cutie (mm)

	125/87	150/100
X1	290	290
Y1	390	390
Z1	130	130

CJ 125

CJ 150

Cod de bare EAN-13	Culori	RAL	Cod de bare EAN-13
4.841.159.000.673	Vișiniu	3005	4.841.159.001.977
4.841.159.000.413	Roșu oxid	3009	4.841.159.001.717
4.841.159.000.154	Roșu	3011	4.841.159.001.458
4.841.159.010.498	Verde crom	6020	4.841.159.010.795
4.841.159.007.238	Gri metalic	7011	4.841.159.007.528
4.841.159.017.015	Gri antracit	7016	4.841.159.017.282
4.841.159.007.818	Cărămiziu	8004	4.841.159.008.105
4.841.159.000.932	Maro	8017	4.841.159.002.233
4.841.159.005.869	Brun	8019	4.841.159.006.156
4.841.159.006.446	Negru	9005	4.841.159.006.736
4.841.159.001.199	Alb	9010	4.841.159.002.493
4.841.159.005.302	Cupru		4.841.159.005.586
4.841.159.004.053	Zinc		4.841.159.004.312

CJ 125 CJ 150

Bucăți în cutie		
	40	25
Cuții pe palet		
	88	88
Cutie		
	13.6	9.9
Palet		
	1215	892

EN 1462:2006

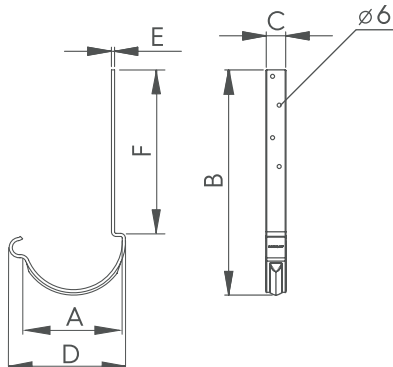

Dimensiuni element (mm)

	125/87	150/100
A	125	150
B	350	375
C	25	25
D	150	177
E	4	4
F	270	270

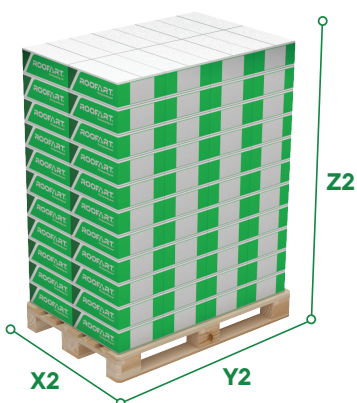

Dimensiuni palet (mm)

	125/87	150/100
X2	800	800
Y2	1200	1200
Z2	1635	1635

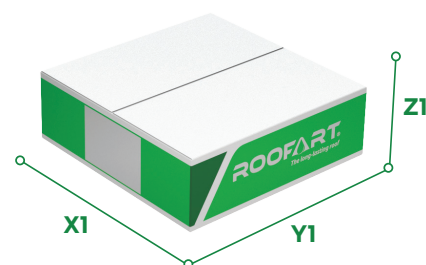

Dimensiuni cutie (mm)

	125/87	150/100
X1	390	390
Y1	390	390
Z1	135	135

CJL 125

Cod de bare EAN-13	Culori
4.841.159.007.009	Vișiniu
4.841.159.007.016	Roșu oxid
4.841.159.007.023	Roșu
4.841.159.010.504	Verde crom
4.841.159.007.078	Gri metalic
4.841.159.017.183	Gri antracit
4.841.159.007.825	Cărămiziu
4.841.159.007.030	Maro
4.841.159.007.047	Brun
4.841.159.007.054	Negru
4.841.159.007.061	Alb
4.841.159.017.596	Cupru
4.841.159.007.085	Zinc

CJL 150

RAL	Cod de bare EAN-13
3005	4.841.159.007.092
3009	4.841.159.007.108
3011	4.841.159.007.115
6020	4.841.159.010.801
7011	4.841.159.007.160
7016	4.841.159.017.299
8004	4.841.159.008.112
8017	4.841.159.007.122
8019	4.841.159.007.139
9005	4.841.159.007.146
9010	4.841.159.007.153
	4.841.159.017.602
	4.841.159.007.177

CJL 125 CJL 150

	CJL 125	CJL 150
Bucăți în cutie		
	30	25
Cuții pe palet		
	66	66
Cutie		
	13	11.6
Palet		
	876	783

EN 1462:2006

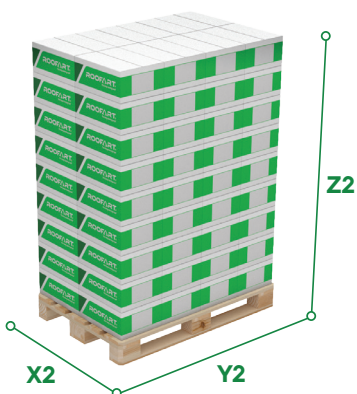

Dimensiuni palet (mm)

	125/87	150/100
X2	800	800
Y2	1200	1200
Z2	1580	1680

CPU 150

CPU 125

Cod de bare EAN-13	Culori	RAL	Cod de bare EAN-13
4.841.159.000.680	Vișiniu	3005	4.841.159.001.984
4.841.159.000.420	Roșu oxid	3009	4.841.159.001.724
4.841.159.000.161	Roșu	3011	4.841.159.001.465
4.841.159.010.511	Verde crom	6020	4.841.159.010.818
4.841.159.007.245	Gri metalic	7011	4.841.159.007.535
4.841.159.017.022	Gri antracit	7016	4.841.159.017.305
4.841.159.007.832	Cărămiziu	8004	4.841.159.008.129
4.841.159.000.949	Maro	8017	4.841.159.002.240
4.841.159.005.876	Brun	8019	4.841.159.006.163
4.841.159.006.453	Negru	9005	4.841.159.006.743
4.841.159.001.205	Alb	9010	4.841.159.002.509
4.841.159.005.319	Cupru		4.841.159.005.593
4.841.159.004.060	Zinc		4.841.159.004.329

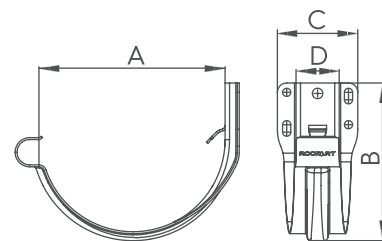

Dimensiuni element (mm)

	125/87	150/100
A	125	150
B	110	137
C	54	57
D	25	25

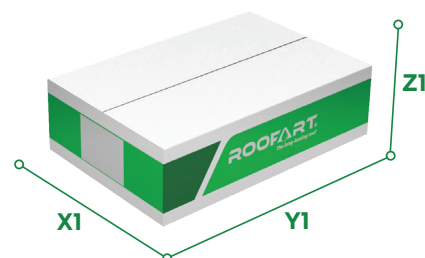

Dimensiuni cutie (mm)

	125/87	150/100
X1	290	290
Y1	390	390
Z1	130	170

CPU 125 CPU 150

	CPU 125	CPU 150
Bucăți în cutie 	30	24
Cuții pe palet 	88	72
Cutie 	4.0	4.2
Palet 	372	322

EN 1462:2006

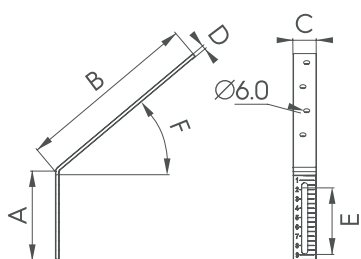

Dimensiuni element (mm)

	125/87	150/100
A	95	95
B	190	190
C	25	25
D	4	4
E	70	70
F	40°	40°

Dimensiuni cutie (mm)

	125/87	150/100
X1	200	200
Y1	300	300
Z1	110	110

Dimensiuni palet (mm)

	125/87	150/100
X2	800	800
Y2	1200	1200
Z2	590	590

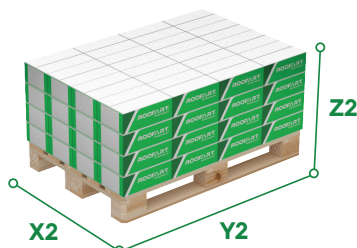
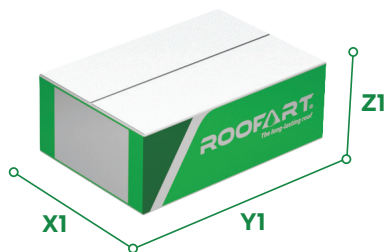

PPC

PPCR

PPC	Bucăți în cutie	PPCR
120		70
64		64
26.0		15.2
1682		992

PPC	
Cod de bare EAN-13	4.841.159.004.077
Material	Oțel zincat

PPCR	
Cod de bare EAN-13	4.841.159.014.946
Material	Oțel zincat

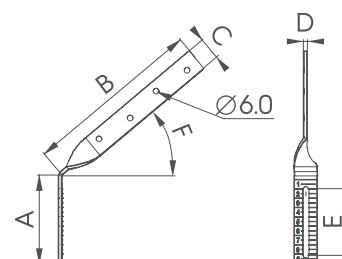

Dimensiuni element (mm)

	125/87	150/100
A	95	95
B	190	190
C	25	25
D	4	4
E	70	70
F	40°	40°

Dimensiuni cutie (mm)

	125/87	150/100
X1	200	200
Y1	300	300
Z1	110	110

Dimensiuni palet (mm)

	125/87	150/100
X2	800	800
Y2	1200	1200
Z2	590	590

**PP
90°**

Piesă preaplin 90°

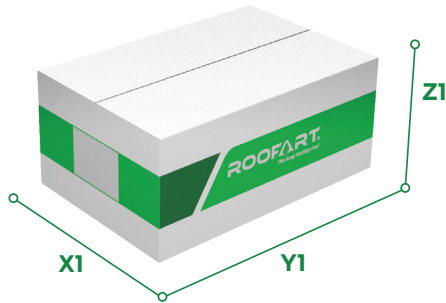
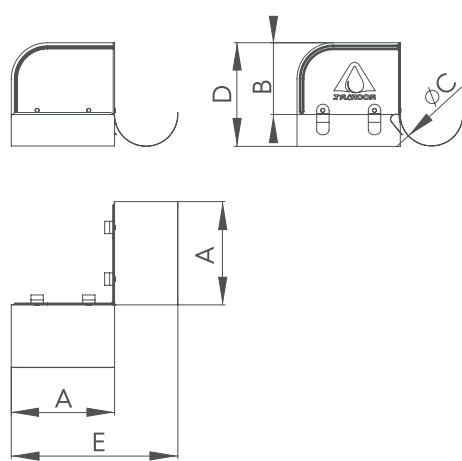

Dimensiuni element (mm)

	125/87	150/100
A	200	200
B	140	140
C	127	153
D	200	200
E	323	350

Dimensiuni palet (mm)

	125/87	150/100
X2	800	800
Y2	1200	1200
Z2	1970	1970

Dimensiuni cutie (mm)

	125/87	150/100
X1	390	390
Y1	590	590
Z1	260	260

PP 125/90°

Cod de bare EAN-13	Culori
4.841.159.005.012	Vișiniu
4.841.159.004.978	Roșu oxid
4.841.159.005.005	Roșu
4.841.159.010.726	Verde crom
4.841.159.007.450	Gri metalic
4.841.159.017.213	Gri antracit
4.841.159.008.037	Cărămiziu
4.841.159.004.985	Maro
4.841.159.006.088	Brun
4.841.159.006.668	Negru
4.841.159.004.992	Alb
4.841.159.005.036	Cupru
4.841.159.005.029	Zinc

PP 150/90°

RAL	Cod de bare EAN-13
3005	4.841.159.005.159
3009	4.841.159.005.111
3011	4.841.159.005.142
6020	4.841.159.011.020
7011	4.841.159.007.740
7016	4.841.159.017.497
8004	4.841.159.008.327
8017	4.841.159.005.128
8019	4.841.159.006.378
9005	4.841.159.006.958
9010	4.841.159.005.135
	4.841.159.005.173
	4.841.159.005.166

PP 125 PP 150

	PP 125	PP 150
Bucăți în cutie		
	6	6
Cuții pe palet		
	28	28
Cutie		
	4.5	5.1
Palet		
	141	158

Notă: Pot exista diferențe între culorile prezentate și cele reale. Pentru siguranță, verificați mostrele de tablă.

**PP
180°**

Piesă preaplin 180°

ROOFART®
Acoperișul durabil

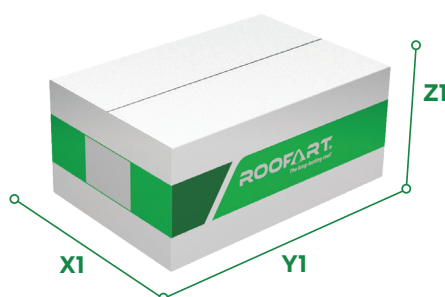
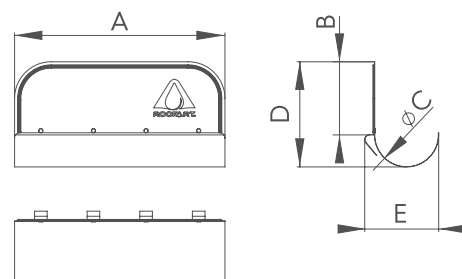

Dimensiuni element (mm)

	125/87	150/100
A	400	400
B	140	140
C	125	150
D	200	230
E	145	170

Dimensiuni palet (mm)

	125/87	150/100
X2	800	800
Y2	1200	1200
Z2	1970	1970

Dimensiuni cutie (mm)

	125/87	150/100
X1	390	390
Y1	590	590
Z1	260	260

PP 125/180°

Cod de bare EAN-13	Colors	RAL	Cod de bare EAN-13
4.841.159.005.081	Vișiniu	3005	4.841.159.005.227
4.841.159.005.043	Roșu oxid	3009	4.841.159.005.180
4.841.159.005.074	Roșu	3011	4.841.159.005.210
4.841.159.010.733	Verde crom	6020	4.841.159.011.037
4.841.159.007.467	Gri metalic	7011	4.841.159.007.757
4.841.159.017.220	Gri antracit	7016	4.841.159.017.510
4.841.159.008.044	Cărămiziu	8004	4.841.159.008.334
4.841.159.005.050	Maro	8017	4.841.159.005.197
4.841.159.006.095	Brun	8019	4.841.159.006.385
4.841.159.006.675	Negru	9005	4.841.159.006.965
4.841.159.005.067	Alb	9010	4.841.159.005.203
4.841.159.005.104	Cupru		4.841.159.005.241
4.841.159.005.098	Zinc		4.841.159.005.234

PP 150/180°

RAL	Cod de bare EAN-13
3005	4.841.159.005.227
3009	4.841.159.005.180
3011	4.841.159.005.210
6020	4.841.159.011.037
7011	4.841.159.007.757
7016	4.841.159.017.510
8004	4.841.159.008.334
8017	4.841.159.005.197
8019	4.841.159.006.385
9005	4.841.159.006.965
9010	4.841.159.005.203
	4.841.159.005.241
	4.841.159.005.234

PP 125 PP 150

	PP 125	PP 150
Bucăți în cutie		
	10	10
Cuții pe palet		
	28	28
Cutie		
	6.8	8.0
Palet		
	210	242

Notă: Pot exista diferențe între culorile prezentate și cele reale. Pentru siguranță, verificați mostrele de tablă.

Colțar interior 90° cu brățări incluse

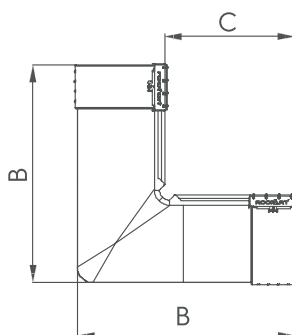
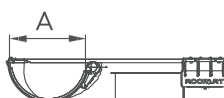

Dimensiuni element (mm)

	125/87	150/100
A	125	150
B	330	350
C	180	180

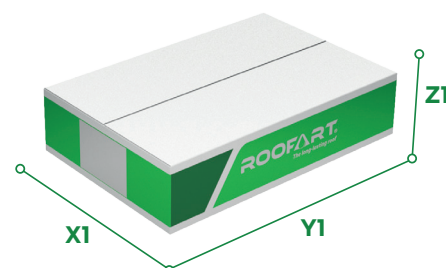

Dimensiuni palet (mm)

	125/87	150/100
X2	800	800
Y2	1200	1200
Z2	1850	1850

Dimensiuni cutie (mm)

	125/87	150/100
X1	390	390
Y1	590	590
Z1	170	170

KIB 125

Cod de bare EAN-13	Culori
4.841.159.014.960	Vișiniu
4.841.159.014.984	Roșu oxid
4.841.159.015.004	Roșu
4.841.159.015.028	Verde crom
4.841.159.015.042	Gri metalic
4.841.159.017.053	Gri antracit
4.841.159.015.066	Cărămiziu
4.841.159.015.080	Maro
4.841.159.015.103	Brun
4.841.159.015.127	Negru
4.841.159.015.141	Alb
4.841.159.015.189	Cupru
4.841.159.015.165	Zinc

KIB 150

RAL	Cod de bare EAN-13
3005	4.841.159.015.448
3009	4.841.159.015.462
3011	4.841.159.015.486
6020	4.841.159.015.509
7011	4.841.159.015.523
7016	4.841.159.017.626
8004	4.841.159.015.547
8017	4.841.159.015.561
8019	4.841.159.015.585
9005	4.841.159.015.608
9010	4.841.159.015.622
	4.841.159.015.660
	4.841.159.015.646

KIB 125 KIB 150

	KIB 125	KIB 150
Bucăți în cutie		
	8	6
Cuții pe palet		
	40	40
Cutie		
	6.0	6.0
Palet		
	260	260

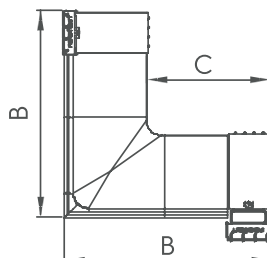
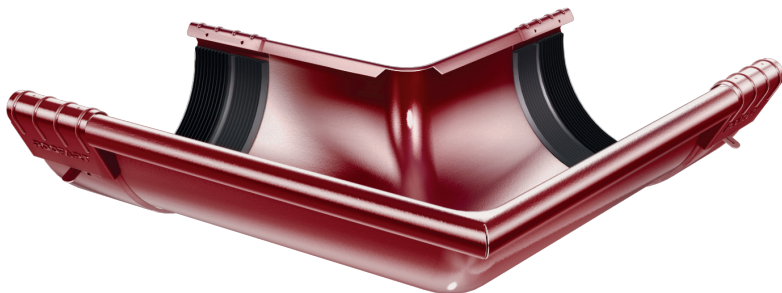

Dimensiuni element (mm)

	125/87	150/100
A	125	150
B	337	350
C	195	180

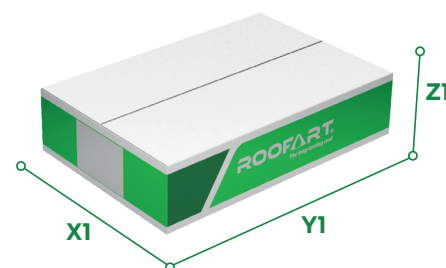

Dimensiuni palet (mm)

	125/87	150/100
X2	800	800
Y2	1200	1200
Z2	1850	1850

Dimensiuni cutie (mm)

	125/87	150/100
X1	390	390
Y1	590	590
Z1	170	170

KEB 125

Cod de bare EAN-13	Culori
4.841.159.014.953	Vișiniu
4.841.159.014.977	Roșu oxid
4.841.159.014.991	Roșu
4.841.159.015.011	Verde crom
4.841.159.015.035	Gri metalic
4.841.159.017.039	Gri antracit
4.841.159.015.059	Cărămiziu
4.841.159.015.073	Maro
4.841.159.015.097	Brun
4.841.159.015.110	Negru
4.841.159.015.134	Alb
4.841.159.015.172	Cupru
4.841.159.015.158	Zinc

KEB 150

RAL	Cod de bare EAN-13
3005	4.841.159.015.431
3009	4.841.159.015.455
3011	4.841.159.015.479
6020	4.841.159.015.493
7011	4.841.159.015.516
7016	4.841.159.017.619
8004	4.841.159.015.530
8017	4.841.159.015.554
8019	4.841.159.015.578
9005	4.841.159.015.592
9010	4.841.159.015.615
	4.841.159.015.653
	4.841.159.015.639

KEB 125 KEB 150

	KEB 125	KEB 150
Bucăți în cutie		
	8	6
Cutii pe palet		
	40	40
Cutie		
	6.2	6.2
Palet		
	268	268

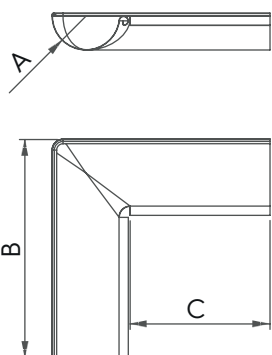

Dimensiuni element (mm)

	125/87	150/100
A	125	150
B	300	300
C	150	120

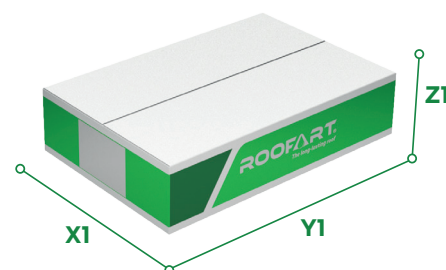

Dimensiuni palet (mm)

	125/87	150/100
X2	800	800
Y2	1200	1200
Z2	1850	1850

Dimensiuni cutie (mm)

	125/87	150/100
X1	390	390
Y1	590	590
Z1	170	170

KI 125

Cod de bare EAN-13	Culori
4.841.159.000.697	Vișiniu
4.841.159.000.437	Roșu oxid
4.841.159.000.178	Roșu
4.841.159.010.528	Verde crom
4.841.159.007.252	Gri metalic
4.841.159.017.534	Gri antracit
4.841.159.007.849	Cărămiziu
4.841.159.000.956	Maro
4.841.159.005.883	Brun
4.841.159.006.460	Negru
4.841.159.001.212	Alb
4.841.159.005.326	Cupru
4.841.159.004.084	Zinc

KI 150

RAL	Cod de bare EAN-13
3005	4.841.159.001.991
3009	4.841.159.001.731
3011	4.841.159.001.472
6020	4.841.159.010.825
7011	4.841.159.007.542
7016	4.841.159.017.312
8004	4.841.159.008.136
8017	4.841.159.002.257
8019	4.841.159.006.170
9005	4.841.159.006.750
9010	4.841.159.002.516
	4.841.159.005.609
	4.841.159.004.336

KI 125

KI 150

Bucăți în cutie		
	10	6
Cuții pe palet		
	40	40
Cutie		
	6.0	4.8
Palet		
	260	210

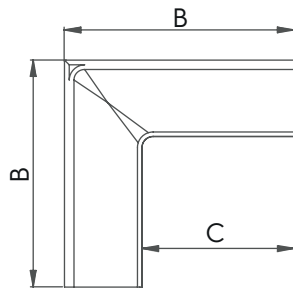
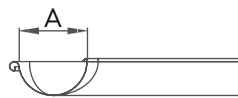

Dimensiuni palet (mm)

	125/87	150/100
X2	800	800
Y2	1200	1200
Z2	1850	1850

Dimensiuni element (mm)

	125/87	150/100
A	125	150
B	300	300
C	150	120

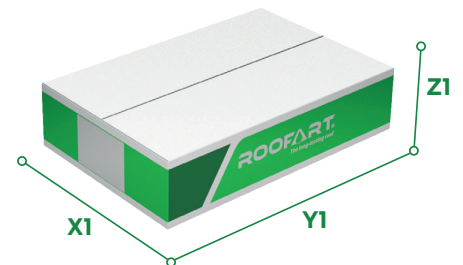

Dimensiuni cutie (mm)

	125/87	150/100
X1	390	390
Y1	590	590
Z1	170	170

KE 125

KE 150

Cod de bare EAN-13	Culori	RAL	Cod de bare EAN-13
4.841.159.000.710	Vișiniu	3005	4.841.159.002.011
4.841.159.000.451	Roșu oxid	3009	4.841.159.001.755
4.841.159.000.192	Roșu	3011	4.841.159.001.496
4.841.159.010.559	Verde crom	6020	4.841.159.010.856
4.841.159.007.283	Gri metalic	7011	4.841.159.007.573
4.841.159.017.527	Gri antracit	7016	4.841.159.017.336
4.841.159.007.870	Cărămiziu	8004	4.841.159.008.167
4.841.159.000.970	Maro	8017	4.841.159.002.271
4.841.159.005.913	Brun	8019	4.841.159.006.200
4.841.159.006.491	Negru	9005	4.841.159.006.781
4.841.159.001.236	Alb	9010	4.841.159.002.530
4.841.159.005.357	Cupru		4.841.159.005.630
4.841.159.004.107	Zinc		4.841.159.004.350

KE 125 KE 150

Bucăți în cutie		
	10	6
Cuții pe palet		
	40	40
Cutie		
	6.0	4.8
Palet		
	260	212

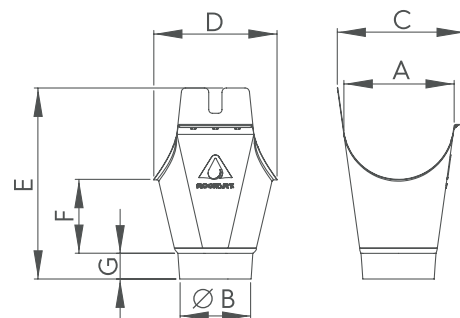

Dimensiuni element (mm)

	125/87	150/100
A	125	150
B	85	95
C	140	170
D	150	168
E	212	265
F	87	110
G	30	40

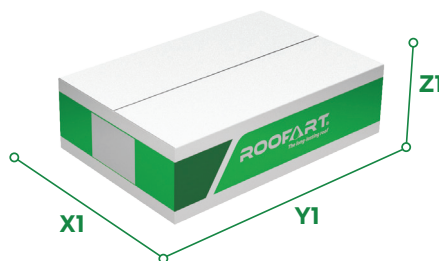

Dimensiuni palet (mm)

	125/87	150/100
X2	800	800
Y2	1200	1200
Z2	1550	1850

Dimensiuni cutie (mm)

	125/87	150/100
X1	390	390
Y1	590	590
Z1	140	170

RA 125

Cod de bare EAN-13	Culori
4.841.159.000.734	Vișiniu
4.841.159.000.475	Roșu oxid
4.841.159.000.215	Roșu
4.841.159.010.580	Verde crom
4.841.159.007.313	Gri metalic
4.841.159.017.077	Gri antracit
4.841.159.007.900	Cărămiziu
4.841.159.000.994	Maro
4.841.159.005.944	Brun
4.841.159.006.521	Negru
4.841.159.001.250	Alb
4.841.159.005.388	Cupru
4.841.159.004.121	Zinc

RA 150

RAL	Cod de bare EAN-13
3005	4.841.159.002.035
3009	4.841.159.001.779
3011	4.841.159.001.519
6020	4.841.159.010.887
7011	4.841.159.007.603
7016	4.841.159.017.350
8004	4.841.159.008.198
8017	4.841.159.002.295
8019	4.841.159.006.231
9005	4.841.159.006.811
9010	4.841.159.002.554
	4.841.159.005.661
	4.841.159.004.374

RA 125 RA 150

Bucăți în cutie		
	24	24
Cuții pe palet		
	40	40
Cutie		
	7.0	9.1
Palet		
	298	384

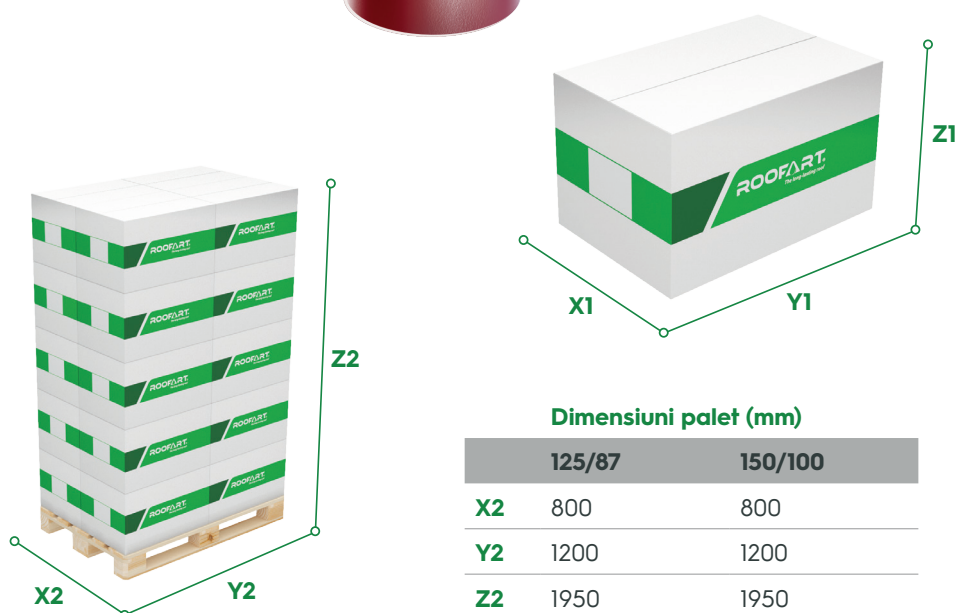
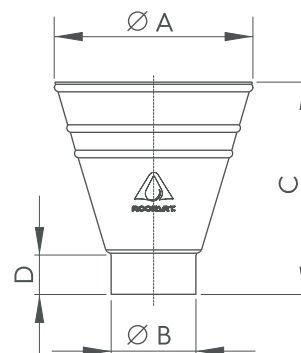
Dimensiuni element (mm)

	125/87	150/100
A	200	250
B	86	98
C	200	250
D	40	40

Dimensiuni palet (mm)

	125/87	150/100
X2	800	800
Y2	1200	1200
Z2	1950	1950

Dimensiuni cutie (mm)

	125/87	150/100
X1	390	390
Y1	590	590
Z1	360	360

PC 87

Cod de bare EAN-13	Culori
4.841.159.000.864	Vișiniu
4.841.159.000.604	Roșu oxid
4.841.159.000.345	Roșu
4.841.159.010.702	Verde crom
4.841.159.007.436	Gri metalic
4.841.159.017.169	Gri antracit
4.841.159.008.013	Cărămiziu
4.841.159.001.120	Maro
4.841.159.006.064	Brun
4.841.159.006.644	Negru
4.841.159.001.380	Alb
4.841.159.005.517	Cupru
4.841.159.004.251	Zinc

PC 100

RAL	Cod de bare EAN-13
3005	4.841.159.002.165
3009	4.841.159.001.908
3011	4.841.159.001.649
6020	4.841.159.011.006
7011	4.841.159.007.726
7016	4.841.159.017.473
8004	4.841.159.008.303
8017	4.841.159.002.424
8019	4.841.159.006.354
9005	4.841.159.006.934
9010	4.841.159.002.684
	4.841.159.005.791
	4.841.159.004.503

PC 87 PC 100

	PC 87	PC 100
Bucăți în cutie		
	20	12
Cuții pe palet		
	20	20
Cutie		
	9.7	8.6
Palet		
	214	192

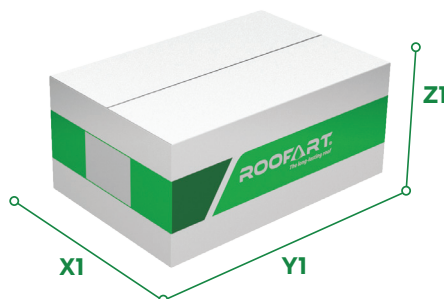
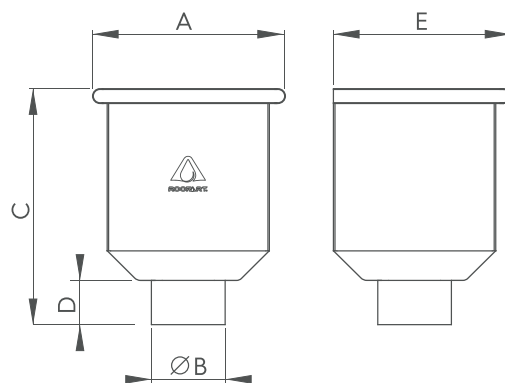
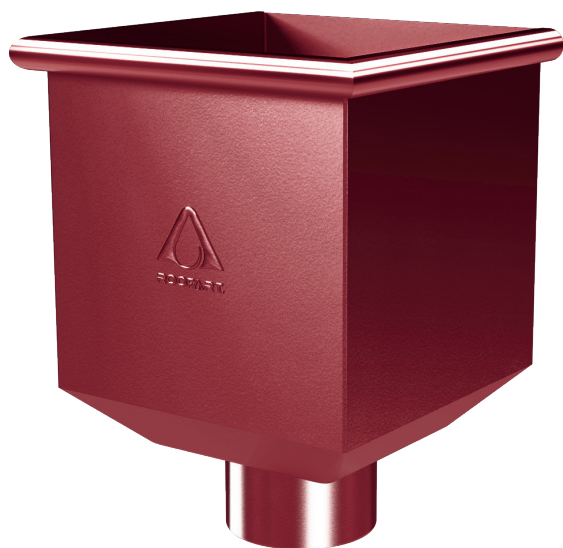

Dimensiuni element (mm)

	125/87	150/100
A	260	260
B	86	98
C	320	320
D	60	60
E	240	240

Dimensiuni palet (mm)

	125/87	150/100
X2	800	800
Y2	1200	1200
Z2	1970	1970

Dimensiuni cutie (mm)

	125/87	150/100
X1	390	390
Y1	590	590
Z1	260	260

PCD 87

Cod de bare EAN-13	Culori
4.841.159.011.150	Vișiniu
4.841.159.011.167	Roșu oxid
4.841.159.011.174	Roșu
4.841.159.011.242	Verde crom
4.841.159.011.181	Gri metalic
4.841.159.017.176	Gri antracit
4.841.159.011.198	Cărămiziu
4.841.159.011.204	Maro
4.841.159.011.211	Brun
4.841.159.011.228	Negru
4.841.159.011.235	Alb
4.841.159.015.295	Cupru
4.841.159.011.259	Zinc

PCD 100

RAL	Cod de bare EAN-13
3005	4.841.159.011.372
3009	4.841.159.011.389
3011	4.841.159.011.396
6020	4.841.159.011.464
7011	4.841.159.011.402
7016	4.841.159.017.480
8004	4.841.159.011.419
8017	4.841.159.011.426
8019	4.841.159.014.335
9005	4.841.159.011.440
9010	4.841.159.011.457
	4.841.159.015.301
	4.841.159.011.471

PCD 87 PCD 100

	PCD 87	PCD 100
Bucăți în cutie 	2	2
Cutii pe palet 	28	28
Cutie 	3.7	3.7
Palet 	124	124

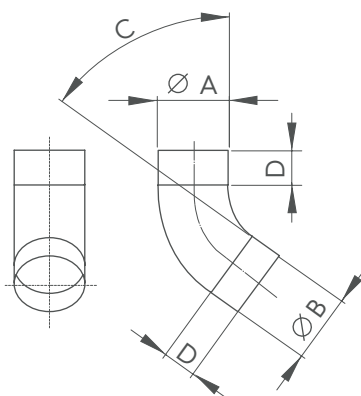

Dimensiuni element (mm)

	125/87	150/100
A	87	100
B	86	98
C	60°	60°
D	50	50

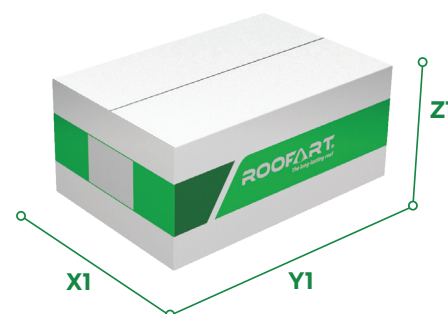

Dimensiuni palet (mm)

	125/87	150/100
X2	800	800
Y2	1200	1200
Z2	1970	1970

Dimensiuni cutie (mm)

	125/87	150/100
X1	390	390
Y1	590	590
Z1	260	260

CB 87

Cod de bare EAN-13	Culori
4.841.159.000.741	Vișiniu
4.841.159.000.482	Roșu oxid
4.841.159.000.222	Roșu
4.841.159.010.597	Verde crom
4.841.159.007.320	Gri metalic
4.841.159.017.084	Gri antracit
4.841.159.007.917	Cărămiziu
4.841.159.001.007	Maro
4.841.159.005.951	Brun
4.841.159.006.538	Negru
4.841.159.001.267	Alb
4.841.159.005.395	Cupru
4.841.159.004.138	Zinc

CB 100

RAL	Cod de bare EAN-13
3005	4.841.159.002.042
3009	4.841.159.001.786
3011	4.841.159.001.526
6020	4.841.159.010.894
7011	4.841.159.007.610
7016	4.841.159.017.367
8004	4.841.159.008.204
8017	4.841.159.002.301
8019	4.841.159.006.248
9005	4.841.159.006.828
9010	4.841.159.002.561
	4.841.159.005.678
	4.841.159.004.381

CB 87 CB 100

	CB 87	CB 100
Bucăți în cutie		
	24	15
Cuții pe palet		
	28	28
Cutie		
	8.2	5.7
Palet		
	250	180

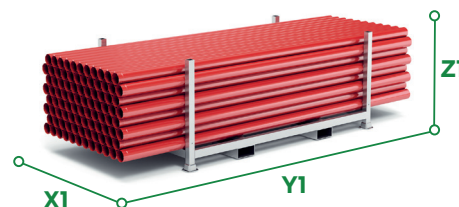

Dimensiuni element (mm)

	125/87	150/100
A	87	100
B	86	98
C	3000	3000
D	50	50
E	45°	45°

Dimensiuni palet (mm)

	125/87	150/100
X1	1200	1200
Y1	3000	3000
Z1	810	810

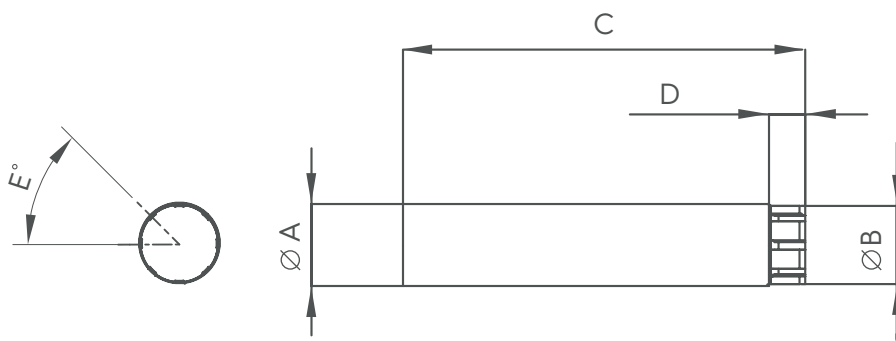

BU 87

BU 100

Cod de bare EAN-13	Culori	RAL	Cod de bare EAN-13
4.841.159.000.796	Vișiniu	3005	4.841.159.002.097
4.841.159.000.536	Roșu oxid	3009	4.841.159.001.830
4.841.159.000.277	Roșu	3011	4.841.159.001.571
4.841.159.010.634	Verde crom	6020	4.841.159.010.931
4.841.159.007.368	Gri metalic	7011	4.841.159.007.658
4.841.159.017.114	Gri antracit	7016	4.841.159.017.398
4.841.159.007.955	Cărmaziu	8004	4.841.159.008.242
4.841.159.001.052	Maro	8017	4.841.159.002.356
4.841.159.005.999	Brun	8019	4.841.159.006.286
4.841.159.006.576	Negru	9005	4.841.159.006.866
4.841.159.001.311	Alb	9010	4.841.159.002.615
4.841.159.005.449	Cupru		4.841.159.005.722
4.841.159.004.183	Zinc		4.841.159.004.435

BU 87 BU 100

Bucăți în pachet		
	2	2
Pachete pe palet		
	36	30
Pachet		
	7.9	8.8
Palet		
	370	347

EN 612:2006

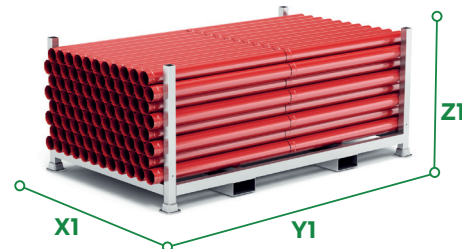

Dimensiuni element (mm)

	125/87	150/100
A	87	100
B	86	98
C	1000	1000
D	50	50
E	45°	45°

Dimensiuni palet (mm)

	125/87	150/100
X1	1200	1200
Y1	2000	2000
Z1	810	810

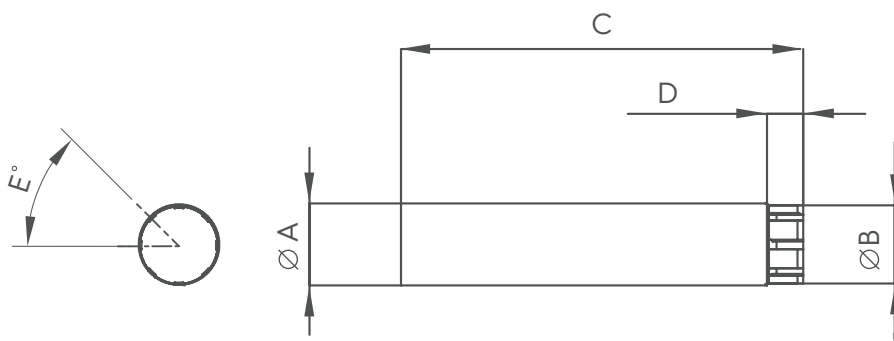

PB 87

PB 100

Cod de bare EAN-13	Culori	RAL	Cod de bare EAN-13
4.841.159.000.765	Vișiniu	3005	4.841.159.002.066
4.841.159.000.505	Roșu oxid	3009	4.841.159.001.809
4.841.159.000.246	Roșu	3011	4.841.159.001.540
4.841.159.010.610	Verde crom	6020	4.841.159.010.917
4.841.159.007.344	Gri metalic	7011	4.841.159.007.634
4.841.159.017.091	Gri antracit	7016	4.841.159.017.374
4.841.159.007.931	Cărămiziu	8004	4.841.159.008.228
4.841.159.001.021	Maro	8017	4.841.159.002.325
4.841.159.005.975	Brun	8019	4.841.159.006.262
4.841.159.006.552	Negru	9005	4.841.159.006.842
4.841.159.001.281	Alb	9010	4.841.159.002.585
4.841.159.005.418	Cupru		4.841.159.005.692
4.841.159.004.152	Zinc		4.841.159.004.404

PB 87 PB 100

	PB 87	PB 100
Bucăți în pachet		
	2	2
Pachete pe palet		
	72	60
Pachet		
	2.6	2.9
Palet		
	274	260

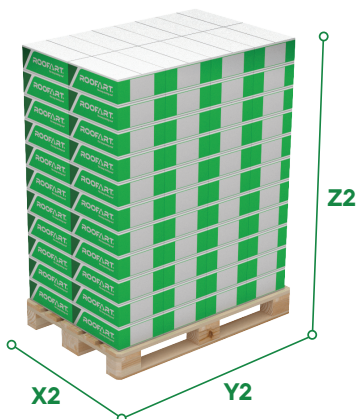
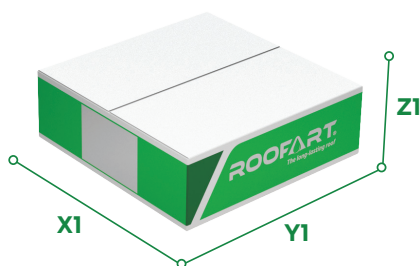
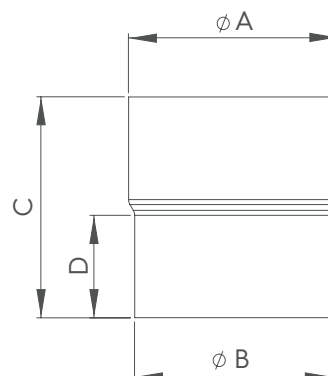

Dimensiuni element (mm)

	125/87	150/100
A	92	103
B	86	98
C	110	110
D	50	50

Dimensiuni palet (mm)

	125/87	150/100
X2	800	800
Y2	1200	1200
Z2	1635	1635

Dimensiuni cutie (mm)

	125/87	150/100
X1	390	390
Y1	390	390
Z1	135	135

MB 87

MB 100

Cod de bare EAN-13	Culori	RAL	Cod de bare EAN-13
4.841.159.011.044	Vișiniu	3005	4.841.159.011.266
4.841.159.011.051	Roșu oxid	3009	4.841.159.011.273
4.841.159.011.068	Roșu	3011	4.841.159.011.280
4.841.159.011.136	Verde crom	6020	4.841.159.011.358
4.841.159.011.075	Gri metalic	7011	4.841.159.011.297
4.841.159.017.206	Gri antracit	7016	4.841.159.017.466
4.841.159.011.082	Cărămiziu	8004	4.841.159.011.303
4.841.159.011.099	Maro	8017	4.841.159.011.310
4.841.159.011.105	Brun	8019	4.841.159.011.327
4.841.159.011.112	Negru	9005	4.841.159.011.334
4.841.159.011.129	Alb	9010	4.841.159.011.341
4.841.159.015.424	Cupru		4.841.159.015.417
4.841.159.011.143	Zinc		4.841.159.011.365

MB 87 MB 100

	MB 87	MB 100
Bucăți în cutie		
	17	14
Cutii pe palet		
	66	66
Cutie		
	2.6	2.4
Palet		
	188	178

Notă: Pot exista diferențe între culorile prezentate și cele reale. Pentru siguranță, verificați mostrele de tablă.

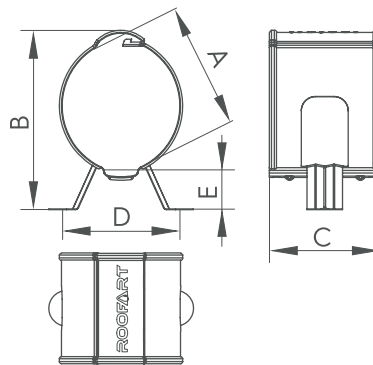

Dimensiuni element (mm)

	125/87	150/100
A	87	100
B	125	150
C	80	80
D	90	90
E	30	30



Dimensiuni palet (mm)

	125/87	150/100
X2	800	800
Y2	1200	1200
Z2	1850	1850

Dimensiuni cutie (mm)

	125/87	150/100
X1	390	390
Y1	590	590
Z1	170	170

BB 87

Cod de bare EAN-13	Culori
4.841.159.000.802	Vișiniu
4.841.159.000.543	Roșu oxid
4.841.159.000.284	Roșu
4.841.159.010.658	Verde crom
4.841.159.007.375	Gri metalic
4.841.159.017.121	Gri antracit
4.841.159.007.962	Cărămiziu
4.841.159.001.069	Maro
4.841.159.006.002	Brun
4.841.159.006.583	Negru
4.841.159.001.328	Alb
4.841.159.005.456	Cupru
4.841.159.004.190	Zinc

BB 100

RAL	Cod de bare EAN-13
3005	4.841.159.002.103
3009	4.841.159.001.847
3011	4.841.159.001.588
6020	4.841.159.010.955
7011	4.841.159.007.665
7016	4.841.159.017.411
8004	4.841.159.008.259
8017	4.841.159.002.363
8019	4.841.159.006.293
9005	4.841.159.006.873
9010	4.841.159.002.622
	4.841.159.005.739
	4.841.159.004.442

BB 87 BB 100

	BB 87	BB 100
Bucăți în cutie		
	44	40
Cuții pe palet		
	40	40
Cutie		
	6.0	6.2
Palet		
	260	268

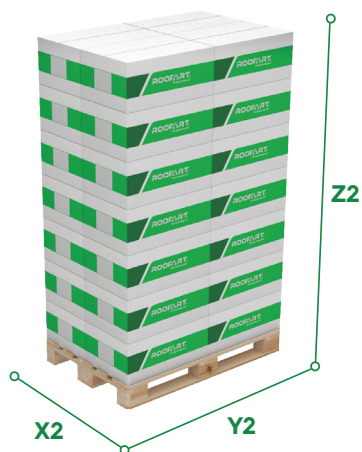
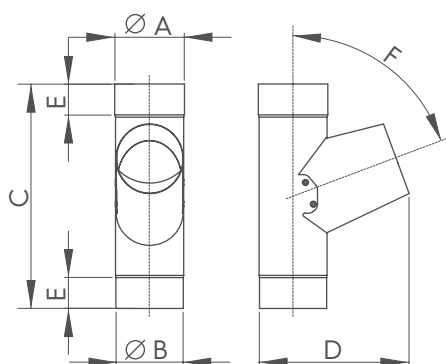
Dimensiuni element (mm)

	125/87	150/100
A	89	100
B	86	98
C	290	310
D	180	190
E	40	40
F	60°	60°

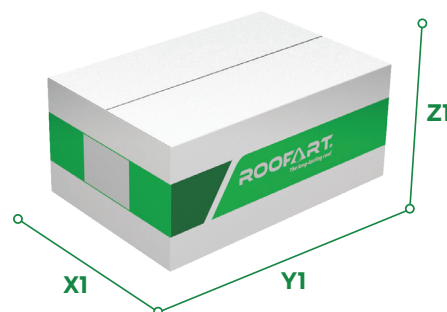
Dimensiuni palet (mm)

	125/87	150/100
X2	800	800
Y2	1200	1200
Z2	1950	1950

Dimensiuni cutie (mm)

	125/87	150/100
X1	390	390
Y1	590	590
Z1	360	360

RB 87
RB 100

Cod de bare EAN-13	Culori	RAL	Cod de bare EAN-13
4.841.159.000.826	Vișiniu	3005	4.841.159.002.127
4.841.159.000.567	Roșu oxid	3009	4.841.159.001.861
4.841.159.000.307	Roșu	3011	4.841.159.001.601
4.841.159.010.665	Verde crom	6020	4.841.159.010.962
4.841.159.007.399	Gri metalic	7011	4.841.159.007.689
4.841.159.017.138	Gri antracit	7016	4.841.159.017.428
4.841.159.007.979	Cărămiziu	8004	4.841.159.008.266
4.841.159.001.083	Maro	8017	4.841.159.002.387
4.841.159.006.026	Brun	8019	4.841.159.006.316
4.841.159.006.606	Negru	9005	4.841.159.006.897
4.841.159.001.342	Alb	9010	4.841.159.002.646
4.841.159.005.470	Cupru		4.841.159.005.753
4.841.159.004.213	Zinc		4.841.159.004.466

RB 87 RB 100

Bucăți în cutie		
	12	10
Cuții pe palet		
	20	20
Cutie		
	6.5	6.9
Palet		
	150	158

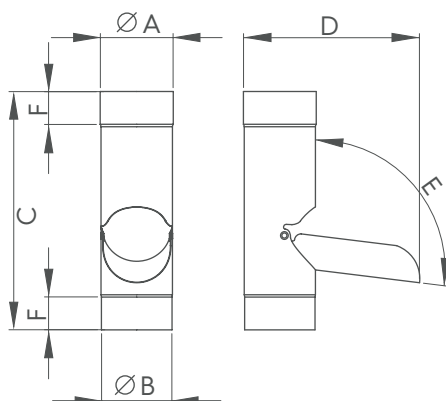

Dimensiuni element (mm)

	125/87	150/100
A	89	100
B	86	98
C	290	350
D	200	230
E	105°	105°
F	40	40

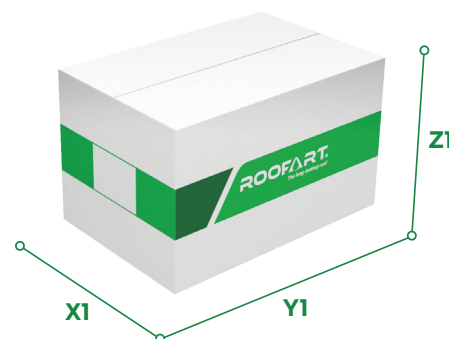

Dimensiuni palet (mm)

	125/87	150/100
X2	800	800
Y2	1200	1200
Z2	1950	1950

Dimensiuni cutie (mm)

	125/87	150/100
X1	390	390
Y1	590	590
Z1	360	360

EC 87

EC 100

Cod de bare EAN-13	Culori	RAL	Cod de bare EAN-13
4.841.159.000.857	Vișiniu	3005	4.841.159.002.158
4.841.159.000.598	Roșu oxid	3009	4.841.159.001.892
4.841.159.000.338	Roșu	3011	4.841.159.001.632
4.841.159.010.696	Verde crom	6020	4.841.159.010.993
4.841.159.007.429	Gri metalic	7011	4.841.159.007.719
4.841.159.017.152	Gri antracit	7016	4.841.159.017.442
4.841.159.008.006	Cărămiziu	8004	4.841.159.008.297
4.841.159.001.113	Maro	8017	4.841.159.002.417
4.841.159.006.057	Brun	8019	4.841.159.006.347
4.841.159.006.637	Negru	9005	4.841.159.006.927
4.841.159.001.373	Alb	9010	4.841.159.002.677
4.841.159.005.500	Cupru		4.841.159.005.784
4.841.159.004.244	Zinc		4.841.159.004.497

EC 87 EC 100

Bucăți în cutie		
	24	20
Cuții pe palet		
	20	20
Cutie		
	11.2	12.8
Palet		
	244	276

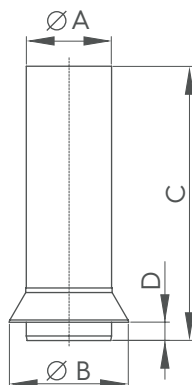

Dimensiuni element (mm)

	125/87	150/100
A	90	104
B	130	145
C	300	310
D	20	20



Dimensiuni palet (mm)

	125/87	150/100
X2	800	800
Y2	1200	1200
Z2	1950	1950

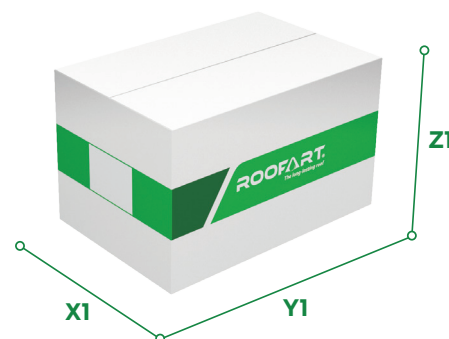

Dimensiuni cutie (mm)

	125/87	150/100
X1	390	390
Y1	590	590
Z1	360	360

RC 87

RC 100

Cod de bare EAN-13	Culori	RAL	Cod de bare EAN-13
4.841.159.000.871	Vișiniu	3005	4.841.159.002.172
4.841.159.000.611	Roșu oxid	3009	4.841.159.001.915
4.841.159.000.352	Roșu	3011	4.841.159.001.656
4.841.159.010.719	Verde crom	6020	4.841.159.011.013
4.841.159.007.443	Gri metalic	7011	4.841.159.007.733
4.841.159.017.190	Gri antracit	7016	4.841.159.017.459
4.841.159.008.020	Cărămiziu	8004	4.841.159.008.310
4.841.159.001.137	Maro	8017	4.841.159.002.431
4.841.159.006.071	Brun	8019	4.841.159.006.361
4.841.159.006.651	Negru	9005	4.841.159.006.941
4.841.159.001.397	Alb	9010	4.841.159.002.691
4.841.159.005.524	Cupru		4.841.159.005.807
4.841.159.004.589	Zinc		4.841.159.004.510

RC 87 RC 100

	RC 87	RC 100
Bucăți în cutie		
	15	12
Cuții pe palet		
	20	20
Cutie		
	8.0	7.2
Palet		
	178	162

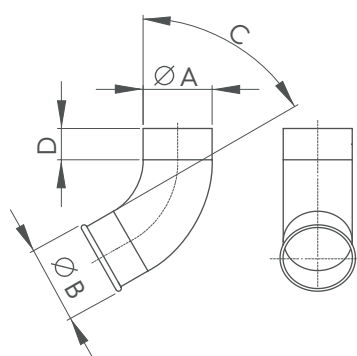

Dimensiuni element (mm)

	125/87	150/100
A	87	100
B	90	103
C	60°	60°
D	50	50

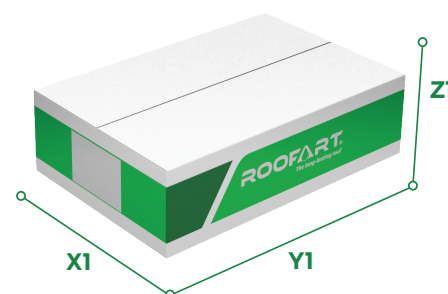

Dimensiuni palet (mm)

	125/87	150/100
X2	800	800
Y2	1200	1200
Z2	1970	1970

Dimensiuni cutie (mm)

	125/87	150/100
X1	390	390
Y1	590	590
Z1	260	260

CE 87

Cod de bare EAN-13	Culori
4.841.159.000.833	Vișiniu
4.841.159.000.574	Roșu oxid
4.841.159.000.314	Roșu
4.841.159.010.672	Verde crom
4.841.159.007.405	Gri metalic
4.841.159.017.145	Gri antracit
4.841.159.007.986	Cărămiziu
4.841.159.001.090	Maro
4.841.159.006.033	Brun
4.841.159.006.613	Negru
4.841.159.001.359	Alb
4.841.159.005.487	Cupru
4.841.159.004.220	Zinc

CE 100

RAL	Cod de bare EAN-13
3005	4.841.159.002.134
3009	4.841.159.001.878
3011	4.841.159.001.618
6020	4.841.159.010.979
7011	4.841.159.007.696
7016	4.841.159.017.435
8004	4.841.159.008.273
8017	4.841.159.002.394
8019	4.841.159.006.323
9005	4.841.159.006.903
9010	4.841.159.002.653
	4.841.159.005.760
	4.841.159.004.473

CE 87 CE 100

	CE 87	CE 100
Bucăți în cutie		
	24	15
Cuții pe palet		
	28	28
Cutie		
	8.2	5.7
Palet		
	250	180

EJ

Element rigidizare jgheab

SJ

Stabilizator jgheab

EN 612:2006

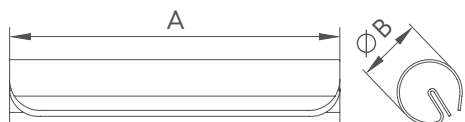

Dimensiuni element (mm)

	125/87	150/100
A	140	140
B	16	18

EJ

EAN-13 barcode	125	4.841.159.006.989
	150	4.841.159.006.996
Material	Oțel zincat	

Dimensiuni cutie (mm)

	125/87	150/100
X1	200	200
Y1	300	300
Z1	110	110

Dimensiuni palet (mm)

	125/87	150/100
X2	800	800
Y2	1200	1200
Z2	590	590

EJ 125	EJ 150		SJ
150	120	Bucăți în cutie 	80
64	64	Cutii pe palet 	64
5.0	4.4	Cutie 	3.8
322	302	Palet 	263

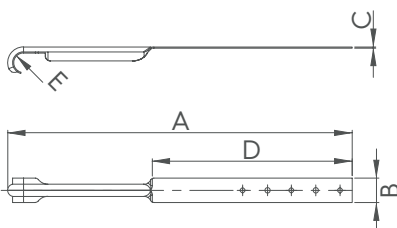

Dimensiuni element (mm)

125/150	
A	283
B	20
C	1.0
D	164
E	R9

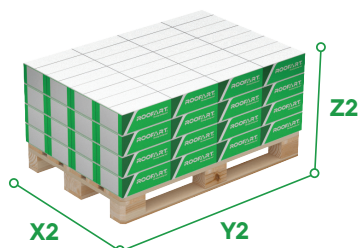
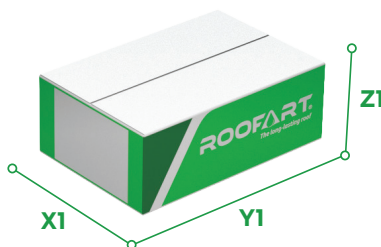

SJ

Cod de bare EAN-13		RAL
4.841.159.015.677		3005
4.841.159.015.684		3009
4.841.159.015.691		3011
4.841.159.015.707		6020
4.841.159.015.714		7011
4.841.159.017.633		7016
4.841.159.015.721		8004
4.841.159.015.738		8017
4.841.159.015.745		8019
4.841.159.015.752		9005
4.841.159.015.769		9010
4.841.159.015.783		Cupru
4.841.159.015.776		Zinc

Dimensiuni cutie (mm)

	125/87	150/100
X1	200	200
Y1	300	300
Z1	110	110

Dimensiuni palet (mm)



	125/87	150/100
X2	800	800
Y2	1200	1200
Z2	590	590

DEP

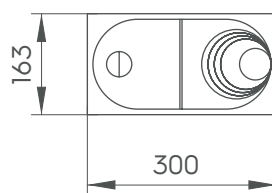
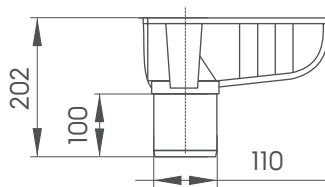
Decantor pluvial

ROOFART®
Acoperișul durabil**DEP**

Cod de bare EAN-13	4.841.159.004.565
Material	Polipropilena

Culori		RAL
Maro		8017
Gri		7035
Grafit		7024

CEL

Cot elastic

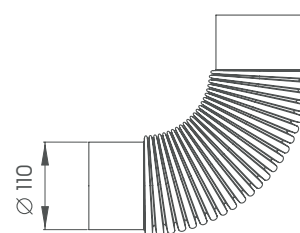
**CEL**

Cod de bare EAN-13	4.841.159.004.572
Material	Polipropilena

Culoare		RAL
Negru		9005

Î.M. ROOFART S.R.L. - Rep. Moldova
mun. Chișinău, str. Muncești 799

☎ +373 79 090 040
✉ info@roofart.md
➔ www.roofart.md

S.C. ROOFART S.R.L. - România
loc. Sîntionlunca, DN11 KM27, com. Ozun, jud. Covasna

☎ +40 372 900 222
✉ contact@roofart.ro
➔ www.roofart.ro

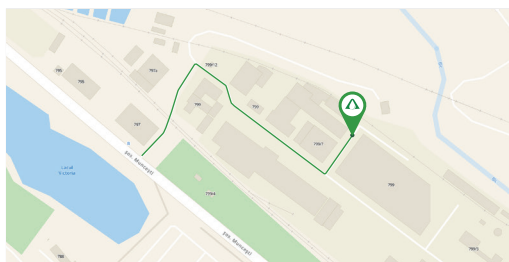

www.roofart.md

